

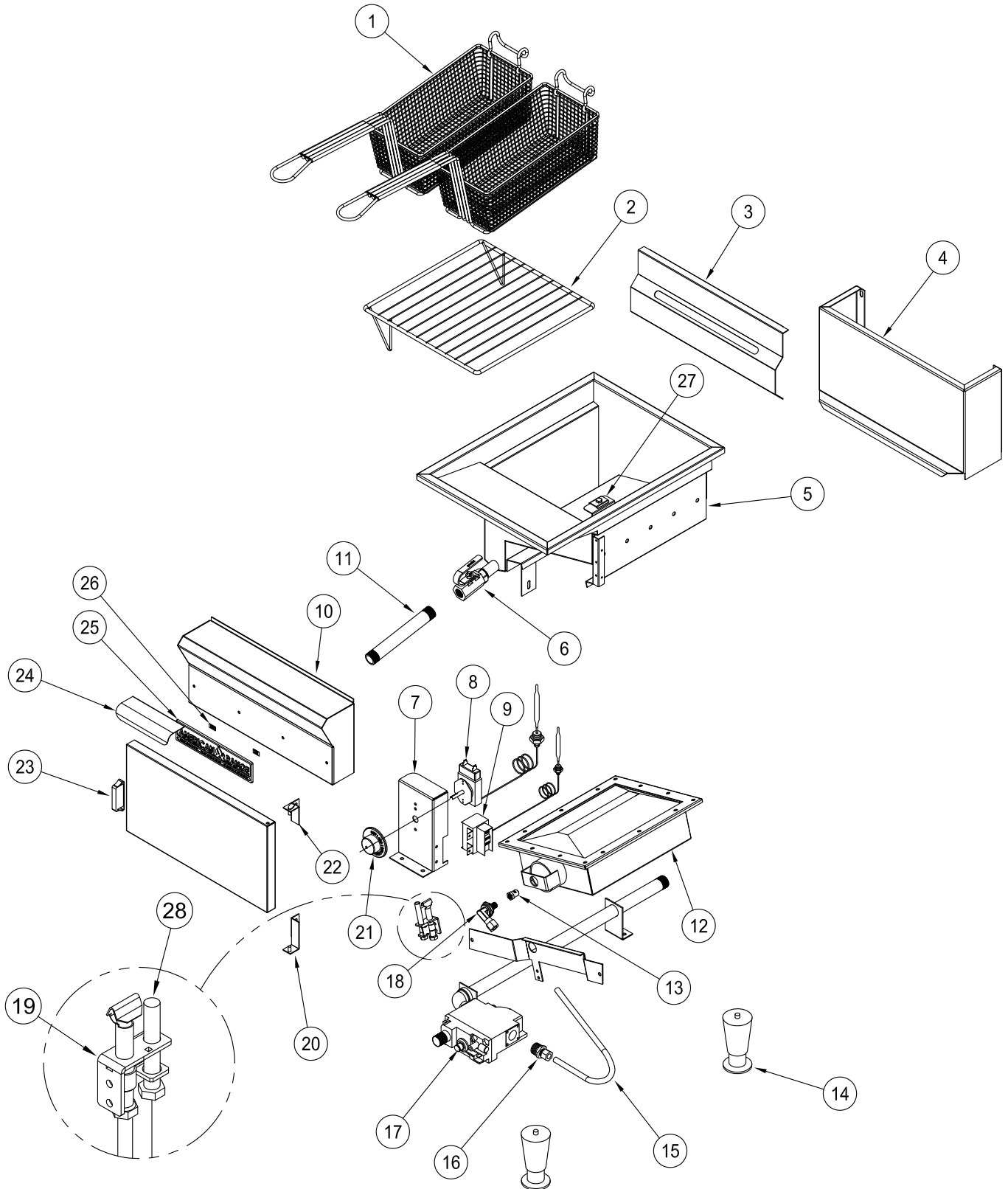







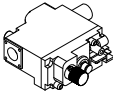
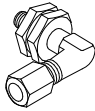
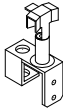

# AFCT-15

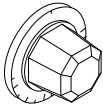

|   |   |  |  |  |  |   |
|---|---|--|--|--|--|---|
| <p>13</p>  <p>ORIFICE HOOD</p>     | <p>16</p>  <p>3/8 NPT x 3/8 CC<br/>BRASS FITTING</p> | <p>17</p>  <p>GAS VALVE</p>                 | <p>18</p>  <p>ORIFICE ELBOW</p> | <p>19</p>  <p>PILOT</p>          | <p>20</p>  <p>DOOR HING, BOTTOM</p> | <p>21</p>  <p>NOB THERMOSTAT</p> |
| <p>22</p>  <p>DOOR HING, TOP</p> | <p>23</p>  <p>DOOR MAGNET</p>                      | <p>25</p>  <p>AMERICAN<br/>NAME PLATE</p> | <p>26</p>  <p>SPEED NUT</p>   | <p>27</p>  <p>PROBE HOLDER</p> | <p>28</p>  <p>THERMOPILE</p>      | <p>29</p>  <p>ORIFICE BELL</p> |

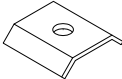
## AFCT-15 Countertop Fryer

| ITEM NO. | PART NO. | DESCRIPTION   | PRICE     |
|----------|----------|---|-----------|
| 1        | A33004   | Basket, AFCT-15 Counter Top Fryer Chrome Plated NSF             | \$ 65.00  |
| 2        | A31088   | Rack, AFCT-15 Screen Chrome Plated                              | \$ 33.00  |
| 3        | 71673    | Hanger, Basket AFCT 71673 18GA Stainless                        | \$ 45.00  |
| 5        | A99360   | Tank, AFCT-15 Fryer 16GA 304SS                                  | \$ 550.00 |
| 6        | A80217   | Valve, Drain AFCT-15 Fryer 1/2"                                 | \$ 150.00 |
| 8        | A50400   | Thermostat, RX Millivolt AF                                     | \$ 80.00  |
| 9        | A10007   | Switch, Hi-Limit Millivolt AF                                   | \$ 99.00  |
| 11       | 71645    | Drain Pipe, 7" AFCT   | \$ 12.00  |
| 12       | A14055   | Burner, AFCT-15 Infra-Red 72079 Ceramic Tile                    | \$ 200.00 |
| 13       | A29000   | Orifice Hood #39 1/2" Brass 11039                               | \$ 2.50   |
|          | A29001   | Orifice Hood #52 1/2" Brass 11052                               | \$ 2.50   |
| 14       | A35010   | Leg, 4" Adjustable AEMG Chrome Plated 1-3/4" Flange Toe NSF     | \$ 18.00  |
|          | A35110   | Leg, 4" Adjustable AEMG Chrome Plated Flange Toe NSF (Set of 4) | \$ 72.00  |
| 15       | A53025   | Tubing, Aluminum 3/8" (Sold Per Foot)                           | \$ 10.00  |
| 17       | A80240   | Valve, Gas AFCT Fryer Nat Gas 6003                              | \$ 160.00 |
|          | A80241   | Valve, Gas AFCT Fryer LP Gas 6003                               | \$ 160.00 |
| 18       | A24001   | Elbow, Orifice Mixr 1/4Px3/8-27 10010                           | \$ 14.00  |
| 19       | A11177   | Pilot, 3CH-6 .016 NAT Gas AFCT                                  | \$ 28.00  |
|          | A11178   | Pilot, 3CH-6 .016 LPG Gas ACB/AFCT                              | \$ 28.00  |
| 20       | 71659    | Hinge, Bottom Door AFCT 71659 Stainless                         | \$ 12.00  |
| 21       | A32013   | Knob, RX Thermostat AF-Series                                   | \$ 8.00   |
| 22       | 71661    | Hinge, Top Door AFCT 71661 Stainless                            | \$ 12.00  |
| 23       | A43104   | Magnet, Door AF Series  | \$ 4.50   |
| 24       | 71677    | Handle, AFCT Heavy Duty 71677 Stainless                         | \$ 10.00  |
| 25       | A38000   | Name Plate, American Range 8" 10499 Quality Commercial Chrome   | \$ 20.00  |
| 26       | A44003   | Nut, Speed #6 Push Black 10601                                  | \$ 0.50   |

All prices subject to change without notice.

