

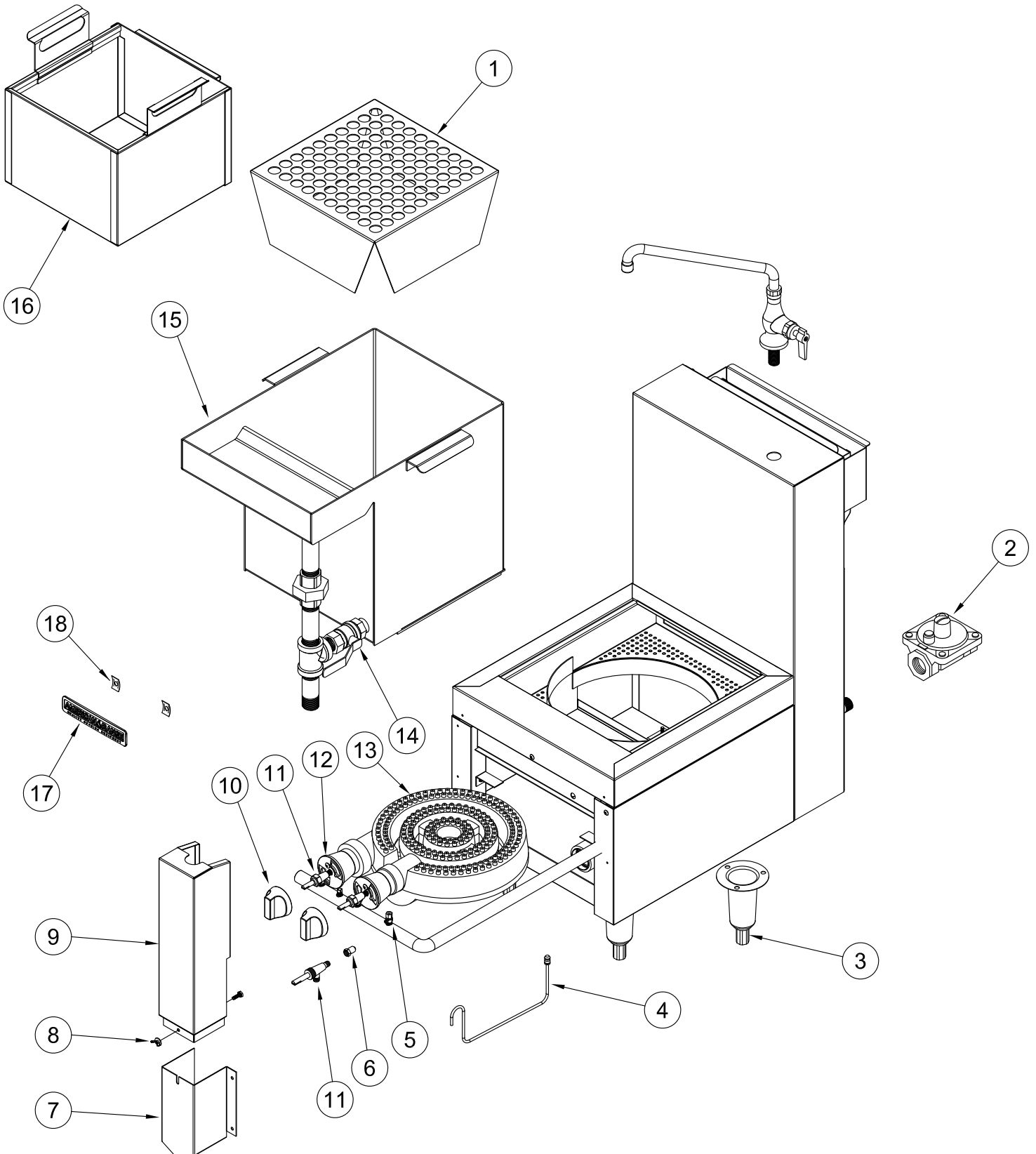

ARPC-18

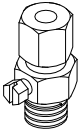
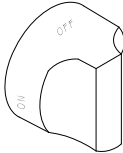
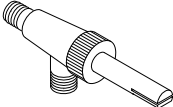
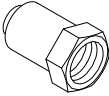
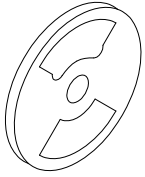

<p>1</p>  <p>90° SINGLE PILOT ADJUSTABLE VALVE</p>	<p>2</p>  <p>BLACK ON/OFF KNOB</p>	<p>3</p>  <p>GAS VALVE</p>	<p>4</p>  <p>ORIFICE HOOD</p>	<p>5</p>  <p>AIR SHUTTER</p>
<p>6</p>  <p>SPEED NUT</p>	<p>7</p>  <p>AMERICAN NAME PLATE</p>	<p>8</p>  <p>REGULATOR</p>		

ARPC - Pasta Cooker

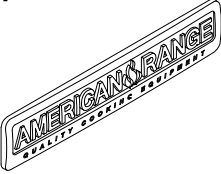
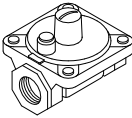
ITEM NO.	PART NO.	DESCRIPTION	PRICE
1	71278	Spacer, Tank Bottom Perforated 14GA 304 2B	\$ 255.00
2	A80110	Valve, Pressure Regulator 3/4" 10480 Nat Gas Set 5.	\$ 34.00
	A80110	Valve Pressure Regulator 3/4" 10481 LPG Gas Set 10.0	\$ 34.00
3	A35001	Leg, 6" Cone 3" Adjustable Bullet Chrome Plated NSF	\$ 40.00
4	A29202	Pilot Tip, Assembly Single 10241 ARSP-18/ARWR/ARPC	\$ 25.00
5	A29302	Valve, Gas Pilot Straight Brass 3/16 CC - 1/8 MNPT	\$ 15.00
6	A29003	Orifice Hood, #53 1/2" Brass Flat Head/MSD LPG Gas ARROB	\$ 2.50
	A29020	Orifice Hood, #31 1/2" Brass 11031 Nat Gas	\$ 2.50
8	A44035	Nut, Wing Flanged 1/4"-20 3/4" ZP 71290 Pasta Cooker	\$ 5.00
9	71295	Bracket, Drain Cover 18GA Stainless 71295 Pasta Cooker	\$ 49.15
10	A32001	Knob, Gas On/Off Glossy Black Flat Down	\$ 14.00
11	A80109	Valve, Gas Manual On/Off UL 10419, AR, ARKB, ARRB, AECB	\$ 25.00
12	A14045	Shutter, Air, 2" 2 & 3 - Ring Burner - ARSP/HD	\$ 4.50
13	A14013	Inner 2 Ring Burner	\$ 139.50
	A80124	Outer Ring Burner ARSP-18 Stock Pot	\$ 129.05
	A14007	Burner, Three Ring Stock Pot w/Venturi 45bx	\$ 337.00
14	A80204	Valve, Drain 1" NPT Brass	\$ 82.50
15	71265	Tank Assembly Aluminum ARPC-18	RFQ
16	71257	Strainer Pot	RFQ
17	A38000	Name Plate, American Range 8" 10499 Quality Commercial Chrome	\$ 20.00
18	A44003	Nut, Speed #6 Push Black 10601	\$ 0.50

All prices subject to change without notice.

