

# ARRDF-Dual Fuel Series

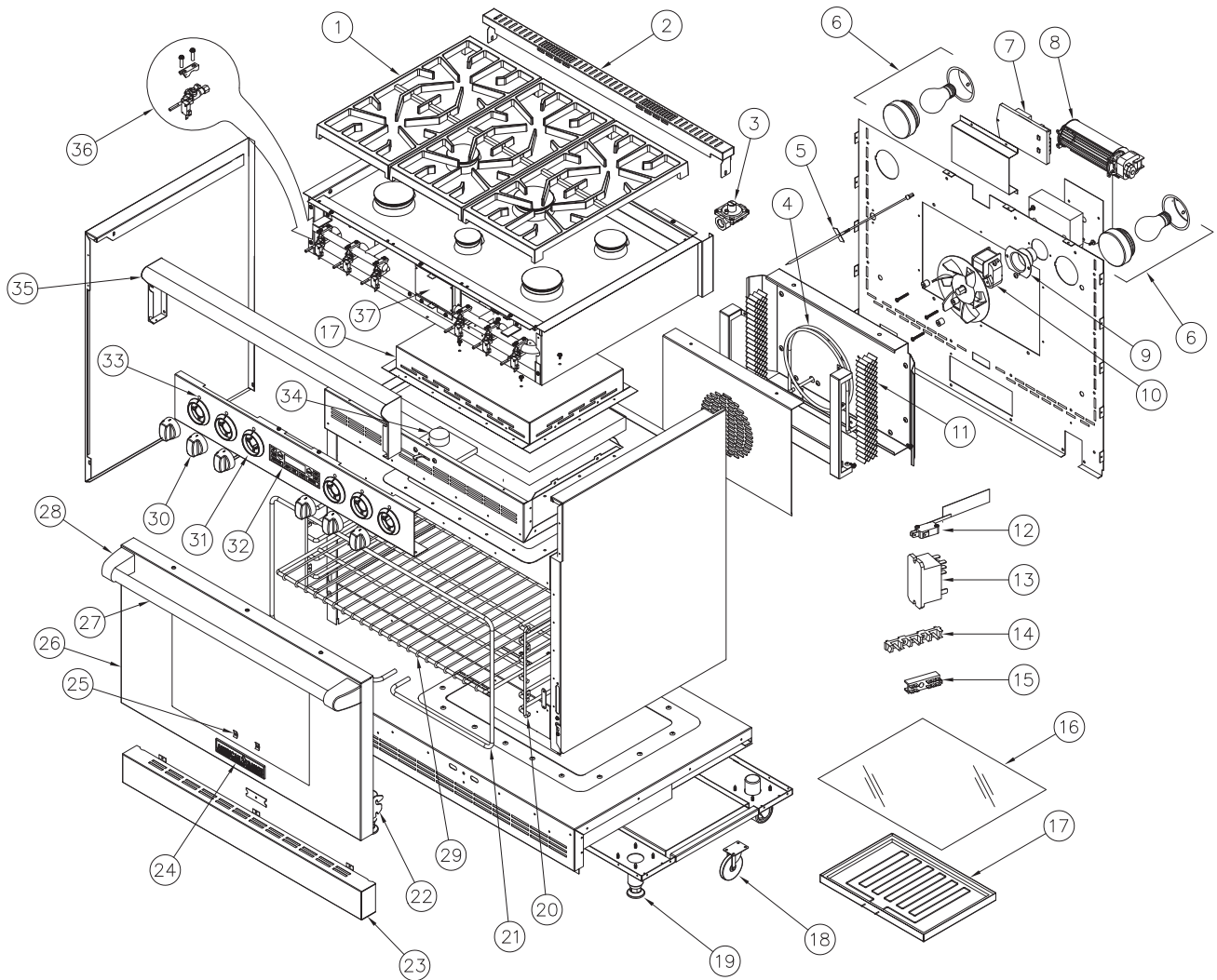

# GRIDDLE

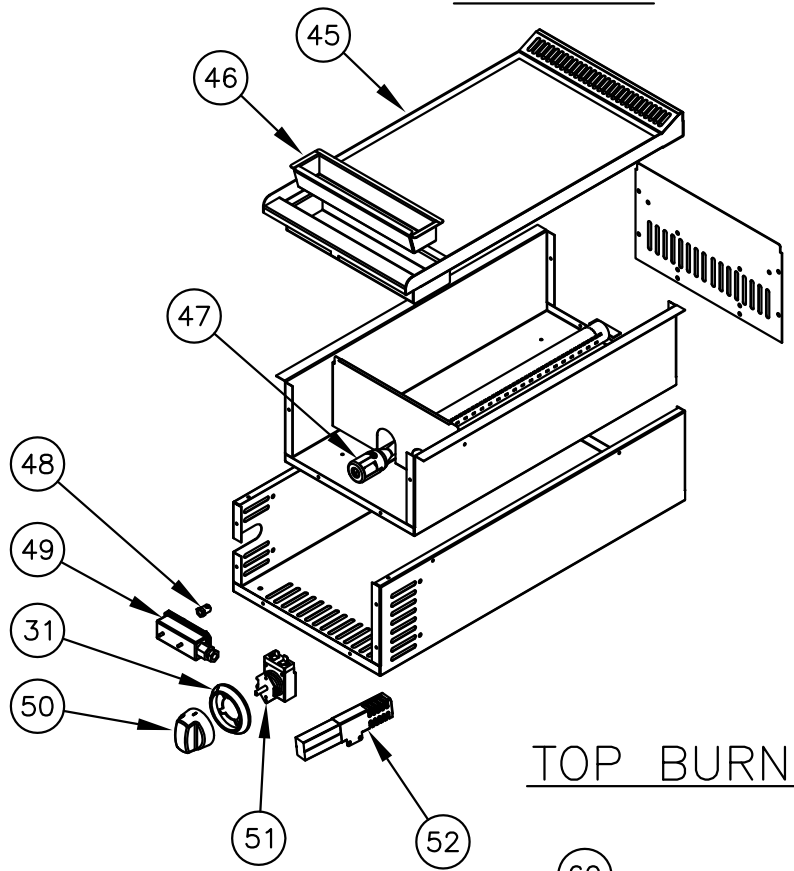

# GRILL

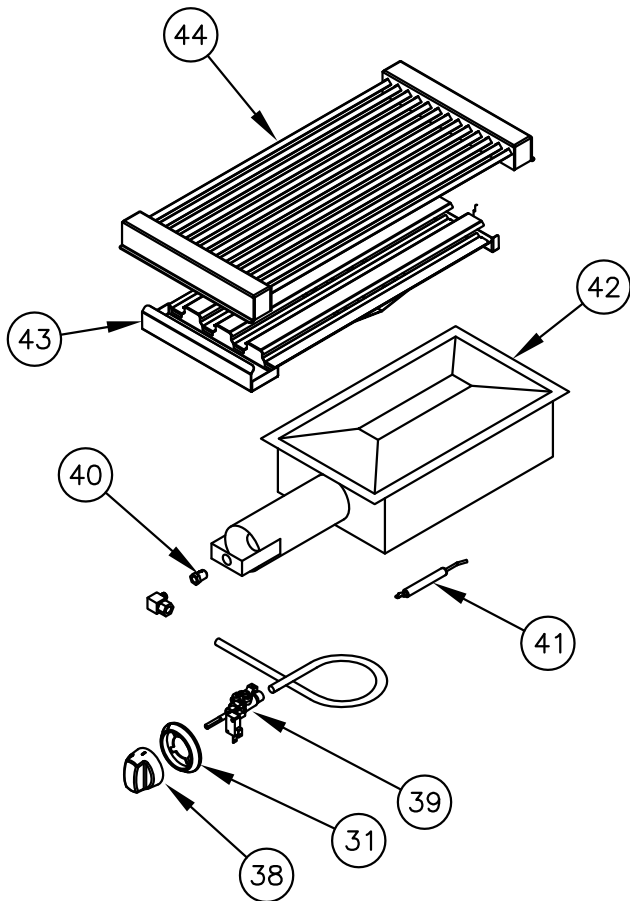

# TOP BURNER

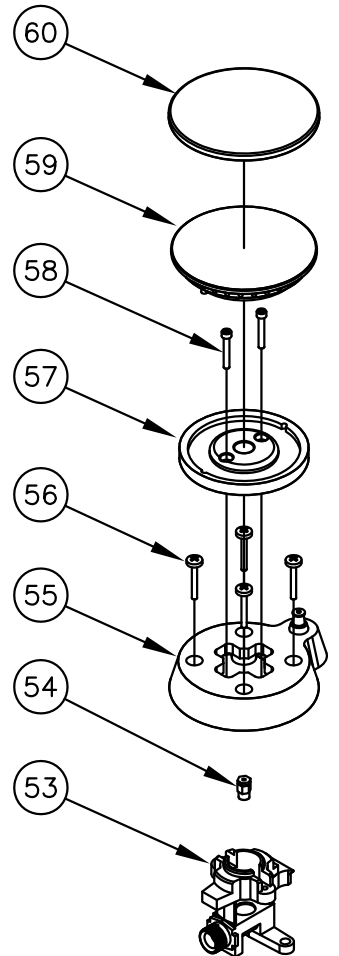

3

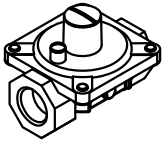

REGULATOR

30



ON/OFF KNOB

31



BEZEL

36

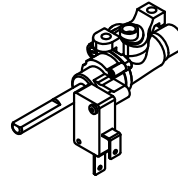

GAS VALVE

41



IGNITER

51

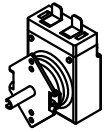

THERMOSTAT

52

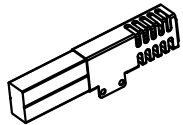

IGNITER

## ARRDF - Dual Fuel Series

ITEM NO.	PART NO.	DESCRIPTION	PRICE
1	R17500	Grate, Top 10.5" X 22.75" Cooktop Residential Range	\$ 185.00
3	R80022	Regulator, Gas 87 CFH Blue 1/2" NPT NAT Gas	\$ 40.00
	R80023	Regulator, Gas 87 CFH Blue 1/2" NPT LP Gas	\$ 40.00
4	R10031	Element, Electric Convection Oven Cell Dual Fuel	\$ 87.00
5	R10026	Sensor, 6" Oven Cell Temperature 1K ohm Medallion DF	\$ 30.04
6	R10002	Light Socket with Glass Cover and Light Bulb	\$ 29.00
7	R10029	Relay, Power Board 30" / 36" Range Dual Fuel	\$ 758.88
8	R10049	Blower Fan, Oven Cell Cooling	\$ 116.55
10	A91100	Motor, Innovection Fan Assembly ARR Range Series	\$ 225.00
11	R18003	Honeycomb, Core Stainless 1"	\$ 53.28
12	R10017	Switch, Air Paddle ARFO / ARWO / ARDF	\$ 72.00
13	R10023	Relay, 30A ARR-DF/AFM/MA Dual Fuel Range, Magma, M/MA	\$ 102.00
14	R10014	Block, Terminal Residential	\$ 15.00
15	R13403	Harness, Bottom Wiring ARRDF-36	\$ 190.00
16	R27010	Glass, Broil/Bake Shield Oven Cell Dual Fuel Range	\$ 233.10
17	R10030	Element, Electric Broiler/Bake 10475 Medallion 3500 Watts	\$ 300.00
18	R35001	Caster 4" Adjustable W/ Brake 250 LB Load Satin Finish	\$ 80.00
19	R35000	Leg, 4" Adjustable W/ Black Glide Boot ARR-Series Range	\$ 29.00
20	R31016	Rack, Guide	\$ 88.00
21	R34000	Gasket, Oven 18" Cell	\$ 31.00
	R34006	Gasket, Oven ARRDF-30"	\$ 50.00
	R34007	Gasket, Oven ARRDF-36"	\$ 50.00
22	R43001	Hinge, Door ARR-30" (2 Per) Heritage / AROSE / Medallion	\$ 125.00
	R43000	Hinge, Door ARR-36" (2 Per) Heritage / AROSE / Medallion	\$ 125.00
	R43003	Hinge, Door ARR-18" (2 Per) Heritage / Medallion	\$ 110.00
23	9060-30	Kick Plate 30" Heritage	\$ 263.00
	9060-36	Kick Plate 36" Heritage	\$ 316.00
	9060-48	Kick Plate 48" Heritage	\$ 421.00
24	R38000	Name Plate, American Range 8"	\$ 30.00
25	A44003	Nut, Speed #6 Push Black 10601	\$ 0.50
26	9529	Door, ARDF-30 Complete Assembly	\$ 617.00
	9528	Door, ARDF-36 Complete Assembly	\$ 747.00
	10359	Door, ARDF-18 Complete Assembly	\$ 349.00
27	R32007	Handle, Oval ARR-18" Door Oven 20922-36 Stainless #180 Finish	\$ 70.00
	R32008	Handle, Oval ARR-24" Door Oven 20922-36 Stainless #180 Finish	\$ 75.00
	R32009	Handle, Oval ARR-30" Door Oven 20922-36 Stainless #180 Finish	\$ 90.00
	R32010	Handle, Oval ARR-36" Door Oven 20922-36 Stainless #180 Finish	\$ 100.00
28	R32006	Endcap, Oven Handle ARR-Series 20391 Heavy Duty Chrome Polish	\$ 40.00
29	R31011	Rack, Oven 18" Heritage / Medallion	\$ 128.00
	R31013	Rack, Oven 30" Heritage / Medallion	\$ 150.00
	R31014	Rack, Oven 36" Heritage / Medallion	\$ 175.00

30	R32016	Knob, Burner Valve Max - Simmer ARR-Series Black New Style	\$ 32.50
31	R32027	Bezel, Knob Chrome Plated ARR-Series Range Slide-In	\$ 25.00
32	R10028	Control, Display Board Dual Fuel Range	\$ 653.33
	R10027	Keypad, Panel Membrane Switch	\$ 98.17
33	R10003	Light, Indicator Blue 115V W/Insu. Terminals QD ARR-Series	\$ 24.00
34	R10025	Latch, Door Motorized Oven Cell Dual Fuel Range	\$ 125.00
35	9062-30	Bullnose, Assembly ARR-30"	\$ 330.00
	9062-36	Bullnose, Assembly ARR-36"	\$ 400.00
	9062-48	Bullnose, Assembly ARR-48"	\$ 530.00
	9062-60	Bullnose, Assembly ARR-60"	\$ 660.00
36	R80003	Valve, Large / Med Burner .065 Simmer Jet 17K BTU/Hr NAT Gas	\$ 60.00
	R80004	Valve, Small Burner .062 Simmer Jet 9K BTU/Hr NAT Gas	\$ 60.00
	R80011	Valve, Large / Med Burner .045 Simmer Jet 17K BTU/Hr LP Gas	\$ 60.00
	R80012	Valve, Small Burner .036 Simmer Jet 9K BTU/Hr NAT Gas	\$ 60.00
37	R10007	Module, Spark 6 Point Residential 120V	\$ 165.00
	R10006	Module, Spark 4 Point Residential 120V	\$ 125.00
	R10008	Module, Spark 1 Point Residential 120V (Used for Grill on Some Models)	\$ 75.00
38	R32025	Knob, Grill IR-Broiler on Black New Style	\$ 32.50
39	R80007	Valve, On/Off Grill Burner NAT Gas 30K BTU/Hr NAT Gas & LPG Purple	\$ 60.00
40	A29018	Hood, Orifice #47 1/2" Brass (Not for Resale)	\$ 2.50
	A29005	Hood, Orifice #55 1/2" Brass (Not for Resale)	\$ 2.50
41	R10052	Electrode, 70" Assembly ARR-Grill W/Orange Wire & Insulation Sleeve	\$ 85.00
42	R14005	Burner, Grill IR Broiler Inconel	\$ 275.00
43	R17571	Cover, Radiant Grill Burner 10224 Performer / Cuisine	\$ 250.00
44	R17520	Grate, Grill ARR-Series	\$ 99.00
45	R92910	Plate, 12" Griddle Assembly 9284-12 ARRGD	\$ 750.00
	R92911	Plate, 24" Griddle Assembly 9284-24 ARRGD	\$ 950.00
46	9285-12	Tray, Grease Assembly for 12" Griddle Plate	\$ 90.00
	9285-24	Tray, Grease Assembly for 24" Griddle Plate	\$ 120.00
47	R14003	Burner, Griddle ARR-Series	\$ 51.00
49	R80002	Valve, Safety Griddle Residential	\$ 200.00
50	R32018	Knob, Griddle Plate Min-Max ARR- Series Black New Style	\$ 32.50
51	R10004	Thermostat, Griddle 18" Cap W/ Sleeve 120VAC 3.6A MT626F	\$ 111.69
52	R10012	Igniter, Ceramic 6.38" Range Blc W/Shield 10" 450C Lead 1/4" QC	\$ 100.00
53	R16509	Orifice, Jet Assembly Large (D, 17K) NAT Gas GD-415-005-004-DOU	\$ 35.00
	R16503	Orifice, Jet Assembly Large (C, 12K) NAT Gas GD-415-005-004-COU	\$ 35.00
	R16518	Orifice, Jet Assembly Large (B, 9K) NAT Gas GD-415-005-004-BOU	\$ 35.00
54	R16523	Orifice, D-Burner #49 1.85mm Sea Level NAT Gas (Not For Resale)	N/A
	R16522	Orifice, C-Burner #52 1.65mm Sea Level NAT Gas (Not For Resale)	N/A
	R16521	Orifice, B-Burner #55 1.33mm Sea Level NAT Gas (Not For Resale)	N/A
	R16510	Orifice, D-Burner #56 1.10mm Sea Level LP Gas (Not For Resale)	N/A
	R16504	Orifice, C-Burner #58 1.07mm Sea Level LP Gas (Not For Resale)	N/A
	R16514	Orifice, B-Burner #65 .090mm Sea Level LP Gas (Not For Resale)	N/A

55	R16010	Spacer, Burner Large Bright Aluminum Finish Cook Top	\$ 99.00
	R16009	Spacer, Burner Medium Bright Aluminum Finish Cook Top	\$ 89.00
	R16008	Spacer, Burner Small Bright Aluminum Finish Cook Top	\$ 79.00
56	A42158	Screw, 10-24 X1 PH Phil MS ZP Type F	\$ 1.00
57	R16508	Base, D-Burner Large	\$ 70.00
	R16502	Base, C-Burner Medium	\$ 60.00
	R16517	Base, B-Burner Small	\$ 50.00
58	A42167	Screw, 6-32 X 7/8 Socket HD C/S SS	\$ 1.00
59	R16506	Head, D-Burner Large, 39-289-003-01	\$ 70.00
	R16500	Head, C-Burner Medium, 39-288-003-01	\$ 60.00
	R16515	Head, B-Burner Small, 39-287-003-01	\$ 50.00
60	R16507	Cap, Top D-Burner Blk Porcelain Enameled Steel 22-046-001-08	\$ 60.00
	R16501	Cap, Top C-Burner Blk Porcelain Enameled Steel 22-046-001-08	\$ 40.00
	R16516	Cap, Top B-Burner Blk Porcelain Enameled Steel 22-046-001-08	\$ 30.00

All prices subject to change without notice.



13592 Desmond St., Pacoima, CA 91331 818.897.0808 888.753.9898 [www.americanrange.com](http://www.americanrange.com)