

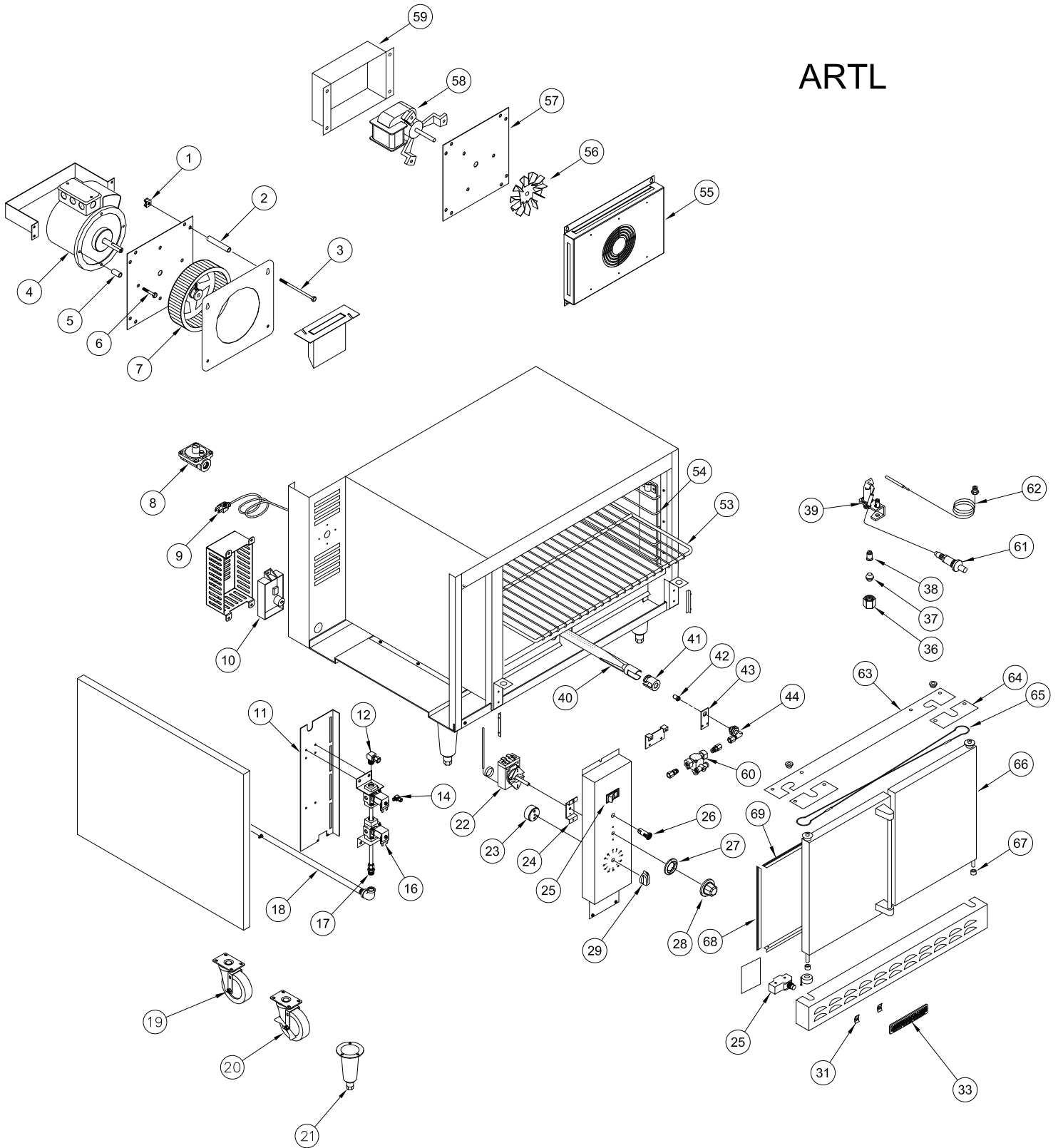

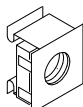

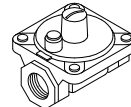

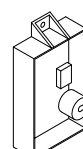

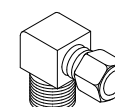
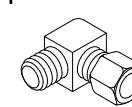
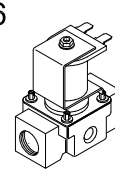

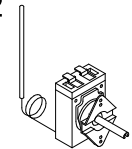
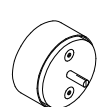
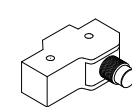
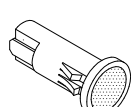

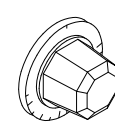
ARTL



<p>1</p>  <p>1/4" FLOAT NUT</p>	<p>8</p>  <p>REGULATOR</p>	<p>10</p>  <p>SPARK MODULE</p>	<p>12</p>  <p>3/8 NPT x 3/8 CC BRASS ELBOW</p>	<p>14</p>  <p>ELBOW 3/16"CC - 1/8"COMPC</p>	<p>16</p>  <p>SOLENOID</p>	<p>17</p>  <p>3/8 NPT x 3/8 CC BRASS FITTING</p>
<p>22</p>  <p>THERMOSTAT</p>	<p>23</p>  <p>TIMER</p>	<p>25</p>  <p>DOOR SWITCH</p>	<p>26</p>  <p>INDICATOR LIGHT</p>	<p>27</p>  <p>BEZEL</p>	<p>28</p>  <p>THERMOSTAT DIAL</p>	<p>29</p>  <p>TIMER KNOB</p>
<p>31</p>  <p>SPEED NUT</p>	<p>33</p>  <p>AMERICAN RANGE NAME PLATE</p>	<p>36</p>  <p>NUT, REDUCER 1/4"CC - 3/16"CC</p>	<p>37</p>  <p>SLEEVE, BALL 3/16" FERRULE</p>	<p>38</p>  <p>ORIFICE BELL</p>	<p>39</p>  <p>IGNITER</p>	<p>42</p>  <p>ORIFICE HOOD</p>
<p>44</p>  <p>ORIFICE ELBOW</p>	<p>61</p>  <p>PIEZO IGNITOR</p>	<p>62</p>  <p>THERMOCOUPLE</p>	<p>63</p>  <p>ROCKER SWITCH</p>			

ARTL

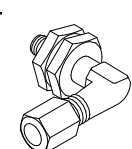
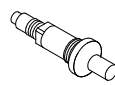
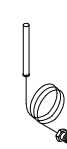
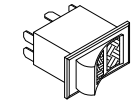
ITEM NO.	PART NO.	DESCRIPTION	PRICE
1	A44001	Nut, Cage 1/4-20 Black	\$ 0.75
2	A43023	Sleeve, 3/8" X 3-16" Stainless	\$ 10.00
3	A42022	Bolt, Hex 1/4 X 5" GRD 5 ZP	\$ 1.00
4	A91004	Motor, ARC 115V 1/5HP 56YZ FLG	\$ 425.00
5	A43026	Spacer Short	\$ 3.00
6	A42004	Bolt, Hex GR5 1/4-20 X 1-3/8	\$ 1.00
7	A91200	Blower, Motor Wheel ARC	\$ 44.00
8	A80110	Valve, Pressure Regulator 3/4" Nat Gas Set 5.0	\$ 34.00
	A80011	Valve, Pressure Regulator 3/4" LPG Gas Set 10.0	\$ 34.00
9	A13100	Cord, Power NEMA 5-15P SJT 16/3	\$ 24.00
10	A10062	Control, Gas Pilot Ignition Pilot Spark 120V MSD/Majestic/SAG	\$ 260.00
11	A99711	Mounting Panel for Components 1328	\$ 14.50
12	A28014	Elbow, 3/8" Compression Brass 10019	\$ 14.00
13	A10052	Spark Cable, Teflon W/ 1/4" QC Insulated Term. Short	\$ 24.00
14	A29303	Elbow, 3/16CC - 1/8 Comp Brass 10000	\$ 7.00
15	A10053	Cable, Flame Sense 3/16" QC Fully Insulated Term. MSD/ARC Short	\$ 9.90
16	A80101	Solenoid, Valve Safety Gas 115V 10415-73462 HD/AR6C/M1/MSD/SAG	\$ 120.00
17	A28032	Fitting, 3/8C X 3/8 MIP Brass	\$ 4.50
18	A15037	Manifold Pipe (Convection) AR 10101	\$ 67.60
19	A35014	Caster, 4" Swivel Plate Mount No Brake NSF AR,AGBU,ACB	\$ 99.00
20	A35015	Caster, 4" Swivel Plate Mount W/Brake NSF AR,AGBU,ACB	\$ 149.00
21	A35001	Leg, 6" Cone 3"Adjustable Bullet	\$ 40.00
22	A11105	Thermostat, KXT Electric M/MSD 10404 ARC/SAG	\$ 100.00
23	A60001	Timer, Cooking 60 Minute 10408 M/MSD/ARC	\$ 56.00
24	A99712	Bracket, KXT Thermostat M/MSD 1330 ARC	\$ 23.00
25	A10009	Switch, Rocker 3 Position 10406 M/MSD Series, ARC	\$ 25.00
	A10002	Switch, Rocker ON/OFF Innovection Oven	\$ 40.00
26	A10011	Light, Indicator 120 V Red 12.7 10407 W/Wire Lead & Male Term	\$ 15.00
27	A32023	Bezel, KXT-397-36 Thermostat 10440-C M/MSD/ARC	\$ 10.00
28	A32005	Knob, Dial KXT Thermostat 10411 M/MSD Series, ARC/SAG	\$ 10.00
29	A32017	Timer, Knob M/MSD Series 10409	\$ 7.50
30	A99708	Gasket Door Sides 1323	\$ 48.00
31	A44003	Nut, Speed #6 Push Black 10601	\$ 0.50
33	A38000	Name Plate, American Range 8" 10499 Quality Commercial Chrome	\$ 20.00
34	A99707	Door Gasket (Top & Bottom) 1322	\$ 50.00

36	A28020	Nut, Reducer 1/4" - 3/16CC	\$ 2.50
37	A28021	Sleeve, Ball 3/16" Tube Barrel Oversize	\$ 2.50
38	A11118	Orifice, Bell .018 AR/AF NAT Gas 11001	\$ 2.50
	A11110	Orifice, Bell .010 LPG Gas 11002	\$ 2.50
39	A11104	Pilot, NAT Gas .018 5SL-2 AR/SAG 10413	\$ 50.00
	A11132	Pilot, LP Gas, .010 AR/SAG 10413L	\$ 50.00
40	R14020	Burner, Bake Oven ARROB/ARRSB/AR Ranges	\$ 40.00
41	A14049	Air Shutter, 1"	\$ 5.00
42	A29000	Orifice Hood, #39 1/2" Brass 11039 Nat Gas (Convection & Innovection)	\$ 2.50
	A29001	Orifice Hood, #52 1/2" Brass 11052 LPG Gas (Convection LP)	\$ 2.50
	A29007	Orifice Hood, #53, 1/2" Brass (Innovection LP)	\$ 2.50
43	A99713	Bracket, Orifice Bracket ARC 1341	\$ 15.65
44	A24000	Elbow, Orifice, Mixr 3/8C-3/8-27 10442	\$ 14.00
45	A99517	Bracket Switch for Door ARC 10122	\$ 32.83
	A99518	Bracket, Door Switch for 60" UNIT 10123	\$ 74.75
46	A10024	Switch, AR6C Oven Door Snap Action Roller/Lever Style	\$ 50.00
53	A31006	Rack, Oven AR-C 10501 25-3/4" X 21-1/2" (Convection)	\$ 160.00
	A31025	Rack, Oven AR6 26-3/8" X 20-7/8" (Innovection)	\$160.00
54	A31008	Rack Guide, ARC Right 1320R (Convection)	\$ 30.63
	A31007	Rack Guide, ARC Left 1320L (Convection)	\$ 30.63
55	A91202	Blower Baffle (Innovection)	\$ 54.08
56	A91206	Fan, Blade Innovection Motor (Innovection)	\$ 32.77
58	A91100	Motor, Innovection Fan Assembly ARR-RANGE Series (Innovection)	\$225.00
60	A80100	Valve, Safety TS-11J AR Ranges 10425	\$120.00
61	A10010	Igniter, Piezo & Locking Nut	\$ 14.00
62	A11100	Thermocouple, 18" 2C AR Range	\$ 24.00
63	A10009	Switch, Rocker 3 Position 10406 M/MSD Series, ARC	\$ 25.00