

MAJESTIC CONVECTION OVEN STANDARD & BAKERY DEPTH

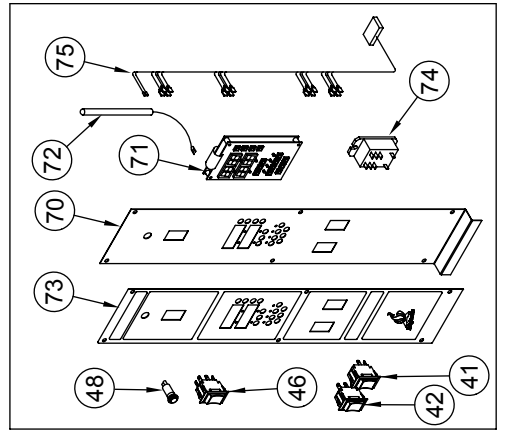

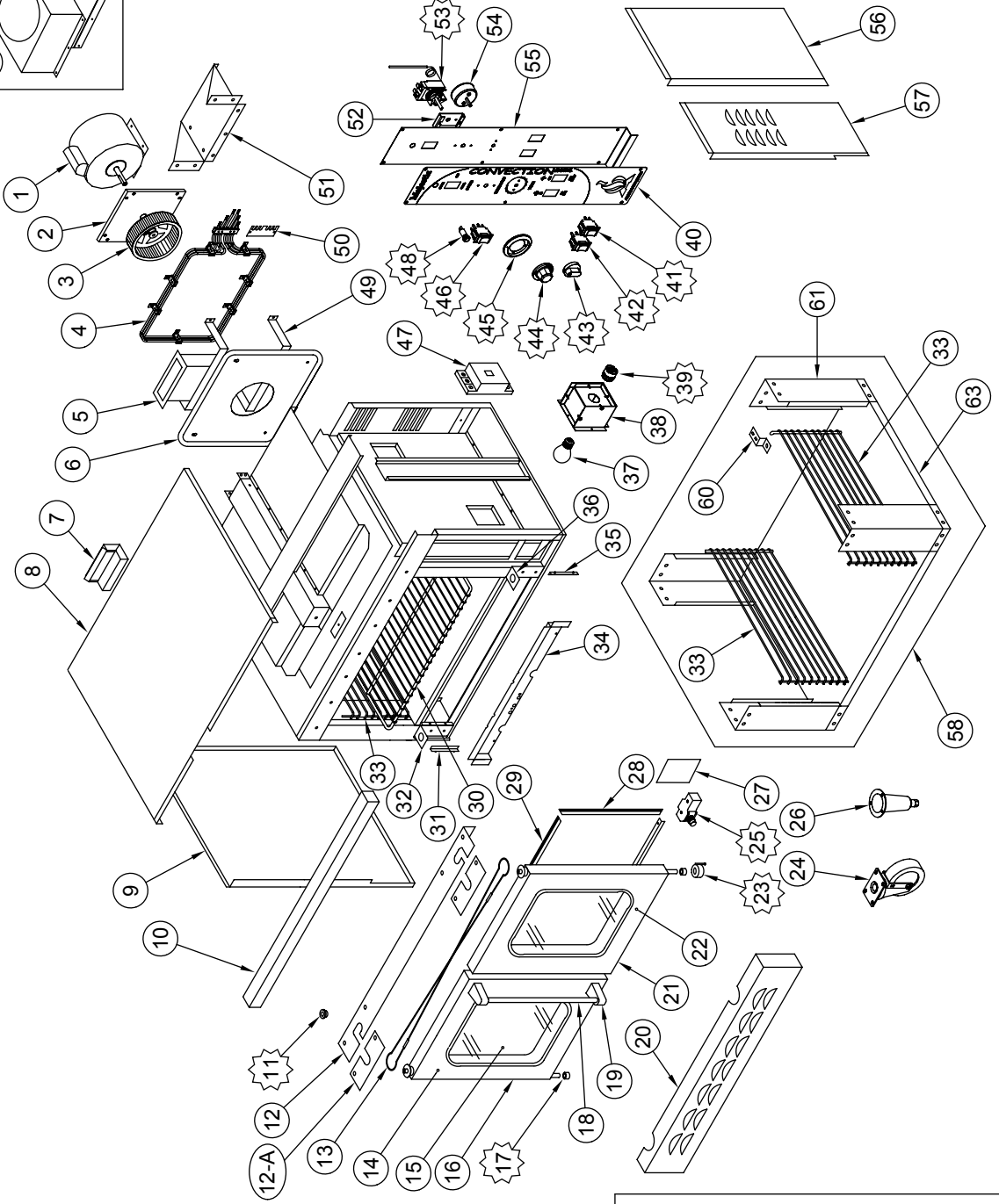

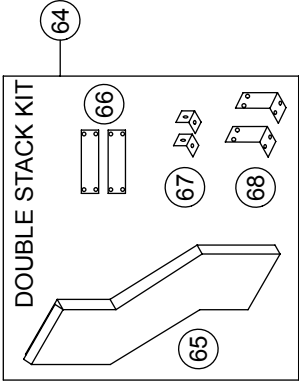

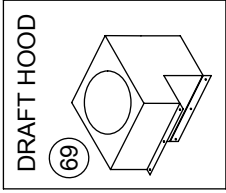

MAJESTIC - ELECTRIC

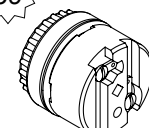

MAJESTIC - ELECTRIC

ITEM NO.	PART NO.	DESCRIPTION
1	A91014	Motor, 1/2HP 50/60HZ 1725/1140 ME/MESD 200-230V 200V 60/50HZ
2	A52530	Mounting Plate, Motor Assembly Insulated M/MSD Series
3	A91201	Blower, Motor Wheel w/Stainless Set Screws M/MSD Series
	A42175	Screw, Set 8mm x 16mm Socket SS M/MSD Blower Wheel
4	A12000	Element, Heating Assembly 9.9KW 3300W Per Rod 208V Incoloy ME
	A12004	Element, Heating Assembly 9.9KW 3300W Per Rod 240V Incoloy ME
5	A53022	Snorkel, Vent Tube Assy M/MSD
6	A52497	Cover, Blower Wheel M/MSD Series Heavy Duty Stainless
7	A99324	Flue Box, Oven M/MSD
8	A99445	Panel, Top Bakery Depth Heavy Duty Stainless M/MA Series
	A99625	Panel, Top Standard Dept Heavy Duty Stainless MSD Series
9	A99444	Panel, Side Left Bakery Depth Heavy Duty Stainless M/MA
	A99622	Panel, Side Left Standard Depth Heavy Duty Stainless MSD Series
10	A99281	Cover, Top Trim M/MSD Series Heavy Duty Stainless
11	A43000	Bushing, Oilite Bronze Flanged M/MSD Series
11A	R43052	Bushing, Flanged Sleeve Bronze 1/2" ID x .875" "New"
12	A99341	Bracket, Door Support Channel 1755B New Style MDS/Majestic
12A	A99303	Bracket, Door Bushing Locking
13	A43108	Chain Majestic
	A43101	Link, Chain M1
	A43005	Rod, 1CV 1/4" x 3" Rt/Lt M/MSD Series
	A43006	Rod, 1CV 1/4" x 20" Rt/Lt ARFO/M1
	A43001	Turnbuckle, 1CV Alum Body M/MSD Series
	A99306	Chain Assembly, M/MSD Door Closing w/Cast Iron Turnbuckle
15	A27005	Glass, Window Pack and J-Trim M-1/MSD
16	A99263	Door, Solid Stainless Left hand Assembly w/Pullarm M/MSD Series
	A99264	Door, Glass Window Pack Stainless Left Side w/Pullarm M/MSD Series
17	A43022	Bearing Sleeve, Bronze 1/2" ID x 3/4" OD 1/2" LG
17A	R43054	Sleeve, Bearing Bronze 1/2" x .750" "New"
18	A53072	Tube, Handle M1/MSD 180 Grit 71955 SS .049W 1-1/4" X 23.40"
19	A32150	Bracket, Door Handle Heavy Duty 18164 Chrome Plated
20	A99471	Kick Plate, Louvered Heavy Duty Stainless M/MSD

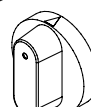
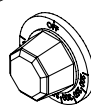
subject to change without notice.

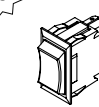
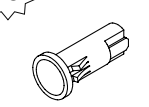
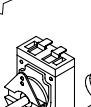
 5/8 BUSHING	 BEARING SLEEVE BRONZE 1/2"IDx3/4"ODx1/2"LG	 SWITCH ACTIVATOR	 DOOR SWITCH	 LIGHT SOCKET	 MOMENTARY SWITCH	 HI/LOW SWITCH
 TIMER KNOB	 KNOB, DIAL KXT THERMOSTAT 10411	 BEZEL	 "ON/OFF/COOL" SWITCH	 INDICATOR LIGHT	 KXT THERMOSTAT	

MAJESTIC - ELECTRIC

ITEM NO.	PART NO.	DESCRIPTION
21	A99265	Door, Solid Stainless Rt Side w/Switch Activator M/MSD Series
	A99266	Door, Glass Window Pack Rt Side w/Switch Activator M/MSD Series
23	A99304	Actuator, Door Switch Collar Assembly M/MSD Series
24	A35018	Caster, 4" Swivel No Brake NSF 300 lb. Load AR/Medallion
	A35019	Caster, 4" Swivel with Brake NSF 300 lb. AR/Medallion
	A35107	Caster, Set (4) 5" Swivel 2/w Brakes 300 lb. Load Majestic/MSD/HD
25	A10003	Switch, Oven Door Plunger with Rubber Boot M/MSD only
26	A35001	Leg, 6" Cone 3" Adjustable Bullet Chrome Plated NSF
27	A99717	Bracket, Door Actuator Switch Stainless M/MSD
28	A99709	Gaskets, Oven Cell Left & Right Spring Stainless Steel M/MSD
29	A99716	Gaskets, Oven Cell Top & Bottom Spring Stainless Steel M/MSD
30	A31000	Rack, Majestic Oven 28-1/2" x 26" Chrome Plated M/MA
	A31082	Rack, Convection Oven MSD Chrome Plated 17.870" x 28.250"
31	A99329	Hinge, Bracket Lt Louver Panel Flat Back M/MSD Series
32	A99233	Bracket, Door Hinge Left Side Heavy Duty Stainless M/MSD
33	A31084	Guide, Rack 27-1/8" x 22-3/4" Chrome Plated M/MA Lt/Rt
	A31081	Guide, Rack 21.40" x 19.19" Chrome Plated MSD Lt/Rt
34	A99280	Baffle, Oven Burner M/MSD Series
35	A99330	Hinge, Bracket Rt Louver Panel Flat Black M/MSD Series
36	A99234	Bracket, Door Hinge Right Side Heavy Duty Stainless M/MSD
37	A20001	Bulb, Light Frosted 40W 130V M/MSD
39	A20000	Socket, Light Porcelain Base 10445 M/MSD/ACB Series
41	A10000	Switch, Rocker On/Off/Momentary MA
42	A10001	Switch, Rocker Fan On/Off/Maintain M/MSD Series
43	A32017	Knob, Timer M/MSD Series 10409
44	A32005	Knob, Dial KXT Thermostat 10411 M/MSD Series, ARC
45	A32023	Bezel, KXT-397-36 Thermostat 10440-C M/MSD Series, ARC
46	A10009	Switch, Rocker 3 Position 10406 M/MSD Series ARC
47	A10058	Contact, 3 Pole 208-240 VAC 50HZ Coil 208/220VAC ME/MSDE
48	A10032	Light, Indicator 220V Red 12.7 w/Wire Lead & Male Terminal ME
50	70815	Cover, Heating Element ME/MSDE
51	A52529	Bracket, Motor Support M/MSD Series
52	A99712	Bracket, KXT Thermostat M/MSD 1330 ARC
53	A11105	Thermostat, KXT Electric M/MSD 10404 ARC
54	A60001	Timer, Cooking 60 Minute 10408 M/MSD, ARC
55	A99593	Panel, Manual Control Heavy Duty Stainless M/MSD
56	A99469	Cover, Panel Rear Heavy Duty Stainless Bakery Depth M/MA
	A99624	Cover, Panel Rear Rt Heavy Duty Stainless MSD Series
57	A99468	Cover, Louvered Panel Front Rt Heavy Duty Stainless M/MSD
60	A99340	Bracket, Undershelf Guide Rack Heavy Duty Stainless M/MSD
61	A35009	Leg, Convection Oven Heavy Duty Stainless Set of 4 M/MSD Series
63	A99261	Shelf, Built-In Utility Heavy 1765 Duty Stainless M/MA
	A99259	Shelf, Built-In Utility Heavy 1765 Duty Stainless MSD/MSDA
64	A37800	Stacking Kit, M/MA-2 Double Oven w/Casters

subject to change without notice.

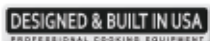

MAJESTIC - ELECTRIC

ITEM NO.	PART NO.	DESCRIPTION
65	A99325	Extension, Flue Box Standard M2/MSD2
	A99472	Extension, Flue Box Direct Vent M2/MSD2
66	A99736	Bracket, Rear Support (B) Majestic
67	A99737	Bracket, Front Support (C) Majestic
68	A99738	Bracket, Flue Box (D) Majestic
69	A37801	Flue Adaptor, Hood Draft Vent Connect Stainless M/MSD Single
	A37804	Flue Adapter, Vent Draft Hood Connect Stainless M/MSD Double W/ Flue Extender
70	71618	Panel, Control Economy 430 Stainless
	71619	Panel, Control Full Featured 430 Stainless
71	A60020	Control, Electronic Cook-N-Hold 71888 Economy W/Ringer MA
	A60021	Control, Electronic Cook-N-Hold 71887 Full Featured Audio MA
72	A60022	Probe, Electronic Cook-N-Hold 71887 Full Featured Audio MA
73	A39022	Label, MA/MSDA Cook-N-Hold 72006 A60021 Full Featured Control
	A39021	Label, MA/MSDA Cook-N-Hold 71618 A60020 Economy Control
74	R10023	Relay, 30A ARR-DF/AFM/MA
75	A13048	Harness, MA/MSDA Full Feature A60019/A10062 Controls
	A37803	Kit, (5) Storage Racks (2) Side Supports with Holders M1/MA
	A37808	Kit, (5) Storage Racks (2) Side Supports with Holders MSD
	A13016	Harness, ME/MSDE Wiring

subject to change without notice.