

Locate Model & Serial Number



For the Legacy Wall Oven series the serial number is under the door on top of the kick panel.

You must open the door to see it on panel.



For Ranges the serial number is under the valve cover/control panel,.

You must open oven door to look under the panel.



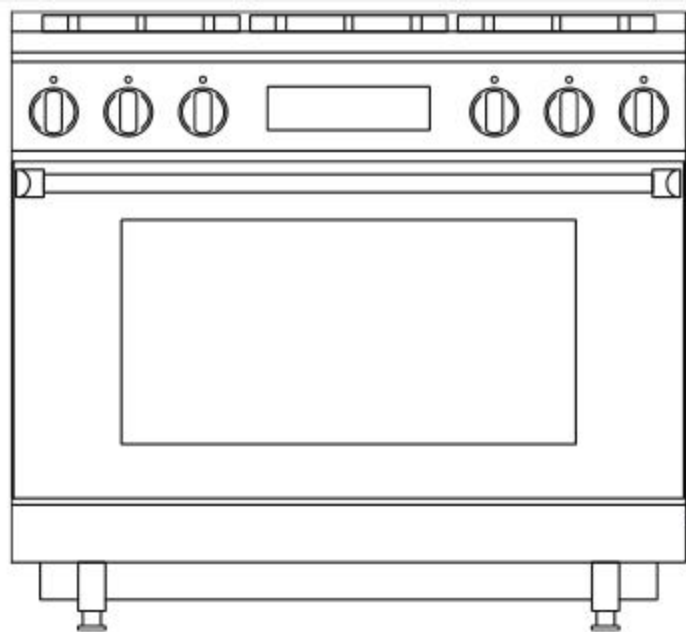

The model and serial number are listed on the data plate located under the control panel or on the kickplate on the front of the appliance.

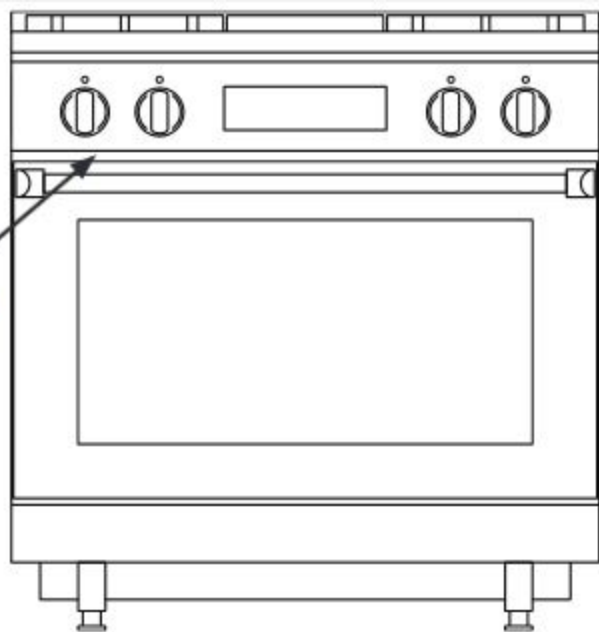

RATING PLATE - The location of the rating plate is shown above. The information on the rating plate defines the model, serial number, gas type (natural or liquid propane), operating pressures and burner BTU ratings. Keep this information for future reference. It is essential for proper identification of the unit when requesting additional information or factory support.

 Intertek 3013256		AMERICAN American Range 13692 DESMOND ST, PACOMA, CA 91331 (www.americarange.com)	
MODEL NO.	ARR-304DF	GAS TYPE <input type="text" value="XXX"/>	
SERIAL NO.	XXXXXX-XXX	MAN. PRESS. <input type="text" value="X.X"/>	
COOK TOP Large <input type="text" value="17,000"/> Medium <input type="text" value="13,500"/> Small <input type="text" value="9,000"/>		BTU INPUT/HR/SECTION	
VOLTS <input type="text" value="240"/>	AMPS <input type="text" value="30"/>	PHASE <input type="text" value="1"/>	CYCLES <input type="text" value="60"/>
BAKE 30 <input type="text" value="3500W"/>	BROIL 30 <input type="text" value="3500W"/>	BAKE 18 <input type="text" value="3500W"/>	BROIL 18 <input type="text" value="3500W"/>
CONVECTION <input type="text" value="2200W"/>		GRIDDLE <input type="text"/>	GRILL <input type="text"/>
ANSI Z21. 1b - HOUSEHOLD COOKING APPLIANCES ANSI AUL 858-2005 CSA C22.2 No. 61 Household Cooking Appliances			

Rating Plate

Model Number Break Down & Burner Configuration

IDENTIFYING THE MODEL NUMBER ON YOUR RESIDENTIAL RANGES (ARR)

MEDALLION SERIES:

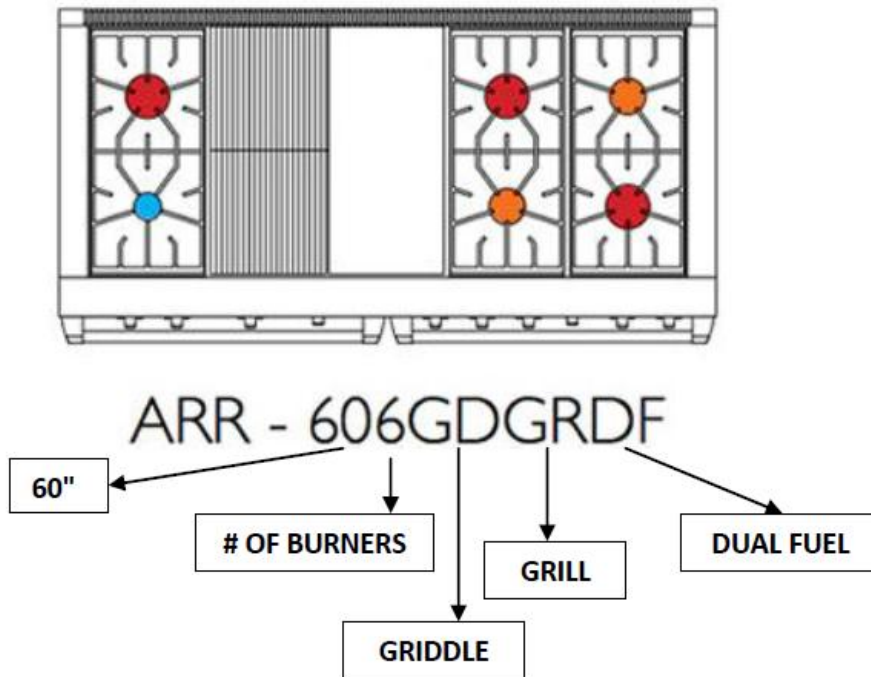

CUISINE SERIES

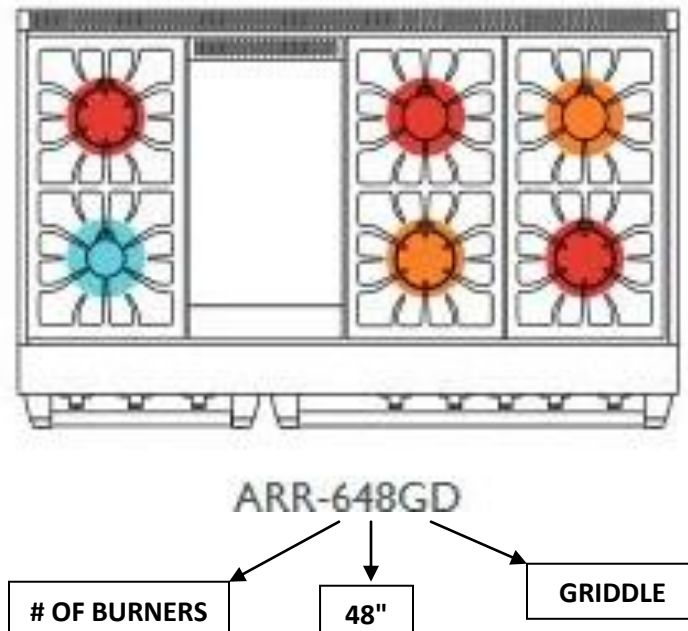

PERFORMER SERIES (OPEN BURNERS)

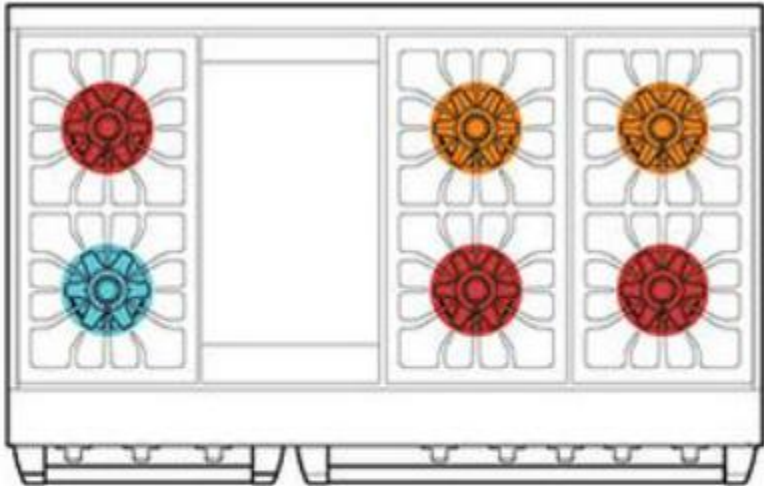

ARROB-648GD

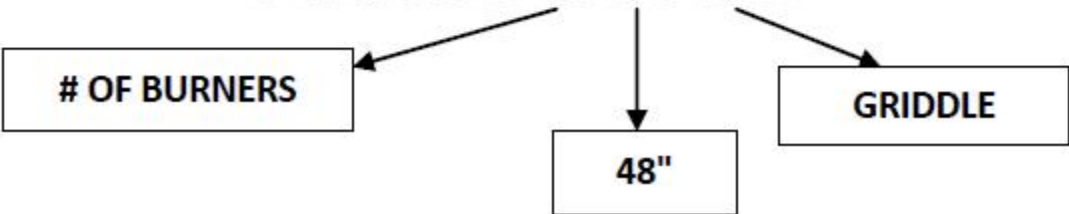

HERITAGE SERIES

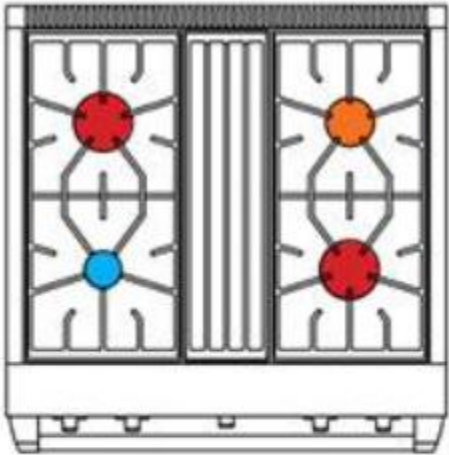

ARR-304

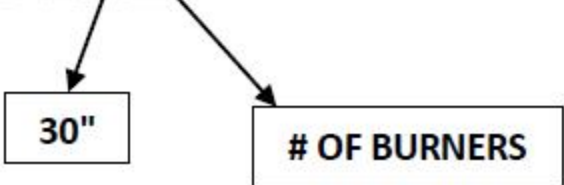

CUISINE & PERFORMER RANGES

MODEL NUMBERS: ARR-530, ARR-636, ARR-436GD, ARR-436GR, ARR-848,ARR-648GD, ARR-648GR, ARR-448GDGR, ARR-4482GD, ARR-4482GR, ARROB-430, ARROB-636, ARROB-436GD, ARROB-436GR, ARROB-648GD, ARROB-648GR, ARROB-448GDGR, ARROB-4482GD ,ARROB-4482GR, ARROB-6602GD, ARROB-6602GR, ARROB-660GDGR

MEDALLION DUAL FUEL RANGES

MODEL NUMBERS: ARR-304DF, ARR-364GDDF, ARR-366DF, ARR-364GRDF, ARR-486GDDF, ARR-484X2GRDF, ARR-486GDGRDF, ARR-4842GDDF, ARR-486GRDF, ARR-606GDGRDF, ARR-6062GDDF, ARR-60X2GRDF

HERITAGE GAS RANGES TITAN GAS RANGES

MODEL NUMBERS: ARR-244, ARR-304, ARR-364GD, ARR-366, ARR-364GR, ARR-486GD, ARR-484X2GR, ARR-484GDGR, ARR-4842GD, ARR-486GR, ARR-606GDGR, ARR-6062GD, ARR-606X2GR, ARR-244IS, ARR-304IS, ARR-366IS

LEGACY WALL OVENS

MODEL NUMBERS:

GAS MODELS: AROFG-30, AROSG-30, AROFFG-230, AROSSG-230, AROFSG-230

ELECTRIC MODELS: AROFE030, AROSE-30, AROFFE-230, AROSSE-230, AROFSE-230

HYBRID MODELS: AROFFHGE-230, AROSSHGE-230, AROFSHGE-230

AMERICAN RANGE

MODEL AND PARTS IDENTIFICATION

DESCRIPTION	HERITAGE SERIES - GAS RANGES												TITAN RANGES			
	ARR-244	ARR-304	ARR-364GD	ARR-366	ARR-364GR	ARR-486GD	ARR-484X2GR	ARR-484GDGR	ARR-4842GD	ARR-486GR	ARR-6062GDGR	ARR-6062GD	ARR-606X2GR	ARR-244IS	ARR-304IS	ARR-366IS
Oven Racks	2	2	2	2	2	4	4	4	4	4	4	4	2	2	2	
Sealed Burners	4	4	4	6	4	6	4	4	4	6	6	6	6	4	4	6
Fixed Rack Guides	2	2	2	2	2	4	4	4	4	4	4	4	4	2	2	2
Center Grate	0	1	0	0	0	0	0	0	0	0	0	0	0	0	0	0
Burner Grates	2	2	2	3	2	3	2	2	2	3	3	3	3	4	4	6
Burner Caps	4	4	4	6	4	6	4	4	4	6	6	6	6	4	4	6
Control Knobs	6	6	7	8	7	11	10	10	10	11	12	12	12	6	6	8
Griddle	0	0	1	0	0	1	2	1	2	0	1	2	0	0	0	0
Stainless Radiant	0	0	0	0	1	0	2	1	0	1	1	0	2	0	0	0
Backyard Grill	0	0	0	0	1	0	2	1	0	1	1	0	2	0	0	0
Regis. Card	1	1	1	1	1	1	1	1	1	1	1	1	1	1	1	1
Island Trim	1	1	1	1	1	1	1	1	1	1	1	1	1	1	1	1
U&C Manual	1	1	1	1	1	1	1	1	1	1	1	1	1	1	1	1
Anti-Tip Device Kit	1	1	1	1	1	1	1	1	1	1	1	1	1	1	1	1

HERITAGE

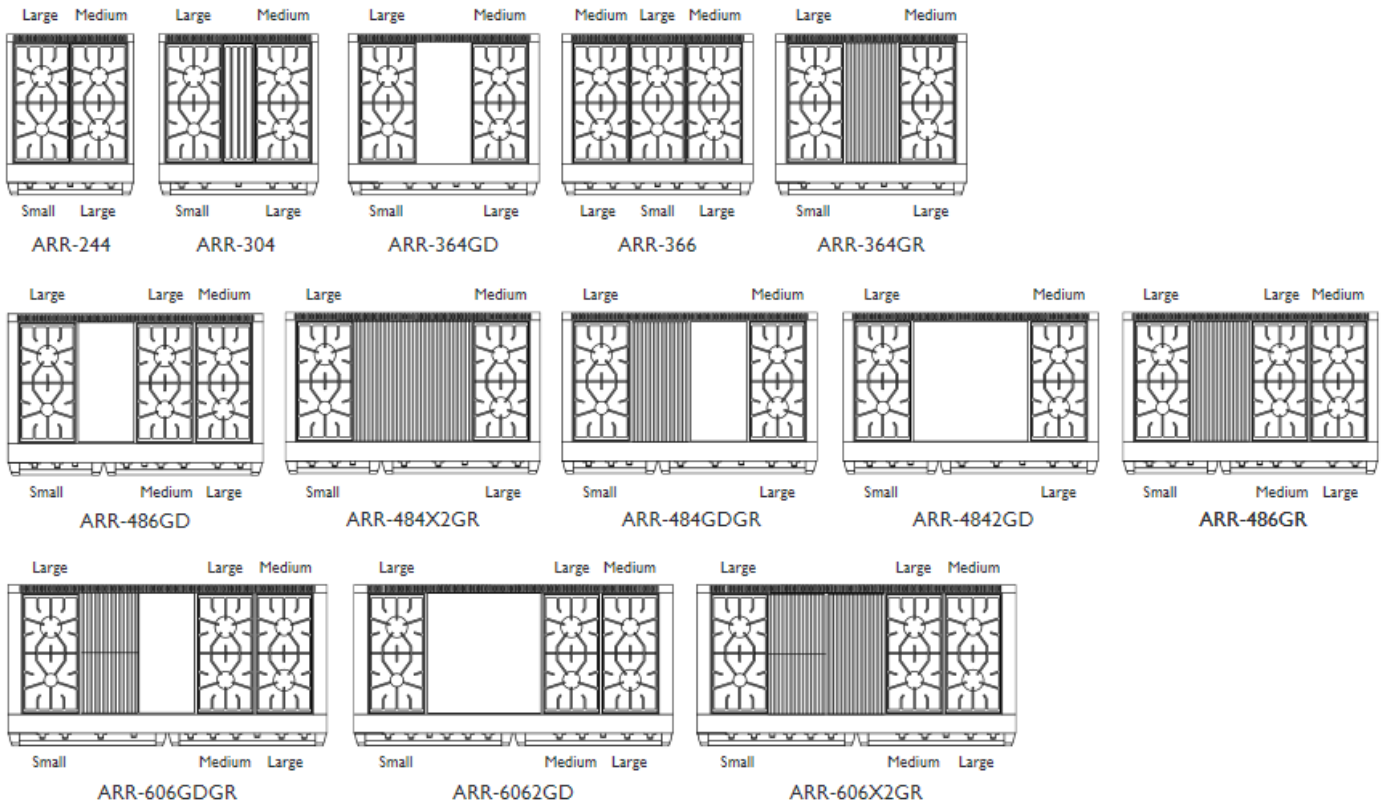

TITAN

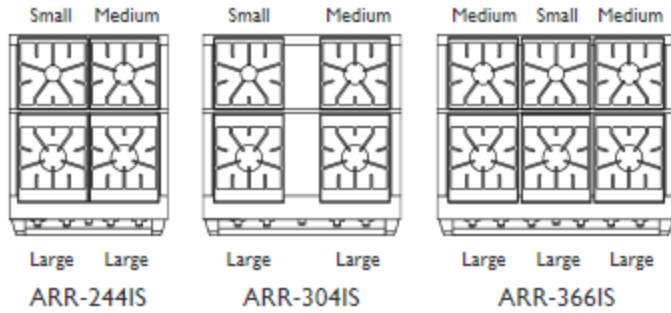

3 SIZES OF BURNERS:

Large Burner	17,000 BTU
Medium Burner	13,000 BTU
Small Burner	9,000 BTU

Heritage & Titan Gas Ranges

TYPICAL MODEL & PARTS IDENTIFICATION

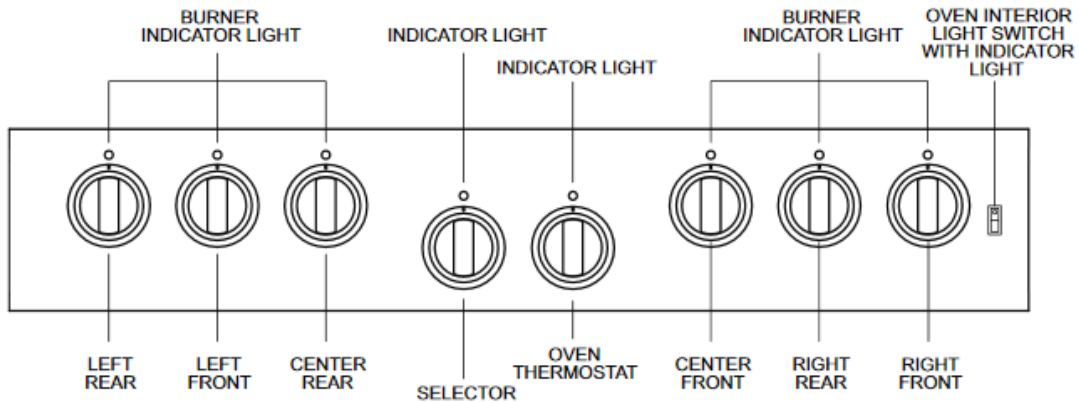

Cuisine & Performer Ranges

TYPICAL MODEL & PARTS IDENTIFICATION

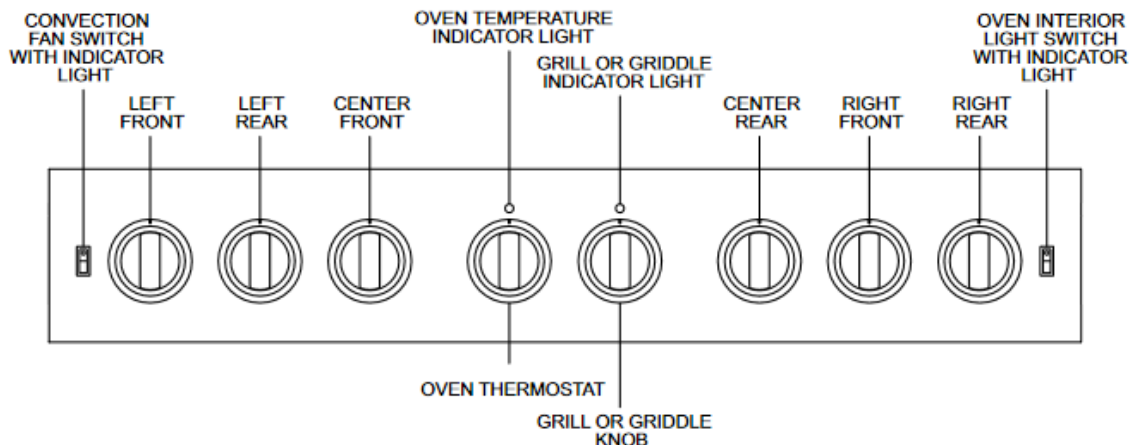

CUISINE SERIES WITH SEALED BURNERS

BURNER CONFIGURATIONS

● 17,000 BTU (lg) ● 13,000 BTU (md) ● 9,000 BTU (sm)

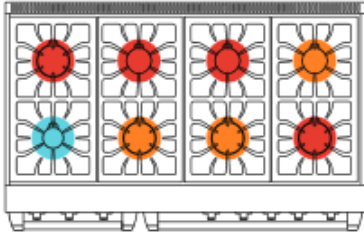

ARR-848

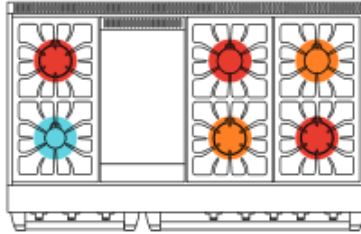

ARR-648GD

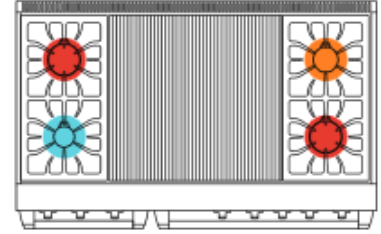

ARR-448X2GR

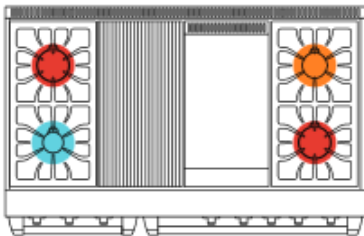

ARR-448GDGR

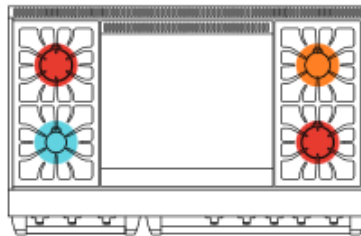

ARR-4482GD

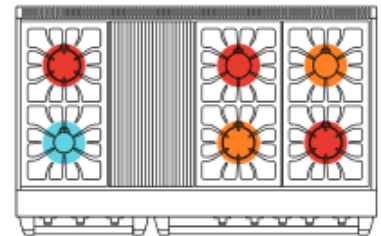

ARR-648GR

N=Natural gas **L**= LP Gas. Must provide **N** or **L** after model number for type of gas needed. **Example: ARR-848-L.**

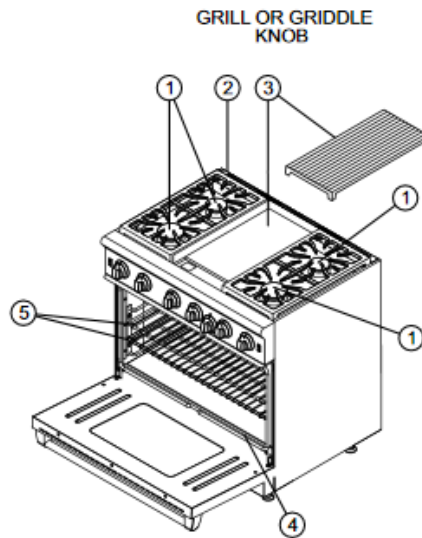

- 1 FOUR SEALED BURNERS WITH PORCELAIN/CAST IRON CAPS AND AUTOMATIC IGNITION / RE-IGNITION
- 2 ISLAND TRIM
- 3 GRIDDLE OR GRILL
- 4 IDENTIFICATION PLATE
- 5 TWO STANDARD HEAVY-DUTY TILT-PROOF RACKS

PERFORMER SERIES WITH OPEN BURNERS

BURNER CONFIGURATIONS

● 25,000 BTU (lg)	● 18,000 BTU (md)	● 12,000 BTU (sm)
-------------------	-------------------	-------------------

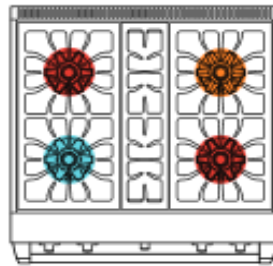

ARROB-130

TOP VIEW

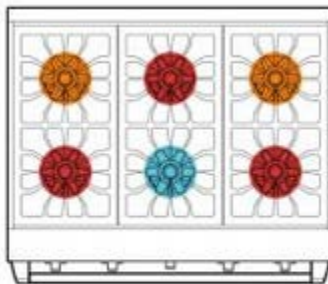

ARROB-636

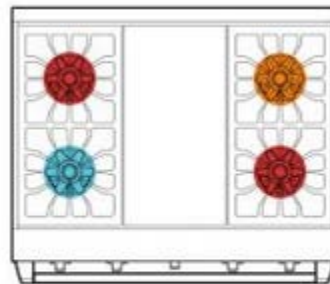

ARROB-436GD

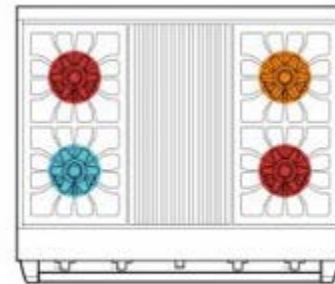

ARROB-436GR

Oven Racks: Each oven is supplied with two heavy chrome-plated adjustable oven racks.

Rack Supports: On each side of the oven, heavy chrome-plated rack supports allow five positions, numbered from the bottom up.

Oven Control Knob: The oven control knob is used to set the Baking temperature or to select the Broil function. During baking, the convection fan may be activated.

Bake Burner: The Bake burner is located in the center of the oven, below the floor and is activated by the Oven Control Knob.

Ceramic Tile Infrared Broil Burner: Positioned in the oven ceiling, burning gas heats the ceramic tile to a temperature of 1,850°F – creating searing heat similar to the glowing coals of a wood fire.

Broil Burner Igniter: The igniter glows a very hot, bright red-orange color, reaching proper ignition temperature to light the Ceramic Tile Infrared Broil Burner.

Burner On Indicator Light: Whenever an oven burner is activated (either Bake or Broil), the burner on indicator will glow. It is normal for the indicator light to cycle off and on during baking or broiling – showing that the requested temperature has been achieved – or that more heat is required.

Door Gasket: The door gasket is made from high temperature materials and creates a seal between the hot oven and the cool kitchen.

Convection Fan and Switch: Operated by the front panel switch, the convection fan circulates oven air, removing the “thermal boundary layer” on items being baked – and in doing so – speeding up heat transfer and cook time by as much as 25%. Convection is active only during baking.

Oven Light and Switch: A single lamp is provided in the oven to illuminate baked and broiled food items, as well as shed some light on the wall to help during clean-up – activated by the front panel switch.

CUISINE BURNER CONFIGURATIONS

30"	36"	48"	60"
<p>ARR-530</p>	<p>ARR-636</p>	<p>ARR-436GD</p>	<p>ARR-436GR</p>
		<p>ARR-848</p>	<p>ARR-648GD</p>
		<p>ARR-448X2GR</p>	<p>ARR-1060</p>
		<p>ARR-448GDGR</p>	<p>ARR-660GDGR</p>
		<p>ARR-4482GD</p>	<p>ARR-6602GD</p>
		<p>ARR-648GR</p>	<p>ARR-660X2GR</p>

● 17,000 BTU (lg) ● 13,000 BTU (md) ● 9,000 BTU (sm)

HERITAGE BURNER CONFIGURATIONS

24"	30"	36"	48"	60"
<p>ARR-244</p>	<p>ARR-304</p>	<p>ARR-366</p>	<p>ARR-486GD</p>	<p>ARR-606GDGR</p>
	<p>ARR-364GD</p>	<p>ARR-364GR</p>	<p>ARR-484X2GR</p>	<p>ARR-6062GD</p>
			<p>ARR-484GDGR</p>	
			<p>ARR-4842GR</p>	<p>ARR-606X2GR</p>
			<p>ARR-4482GR</p>	

● 17,000 BTU (lg) ● 13,000 BTU (md) ● 9,000 BTU (sm)

LEGEND SLIDE-IN BURNER CONFIGURATIONS

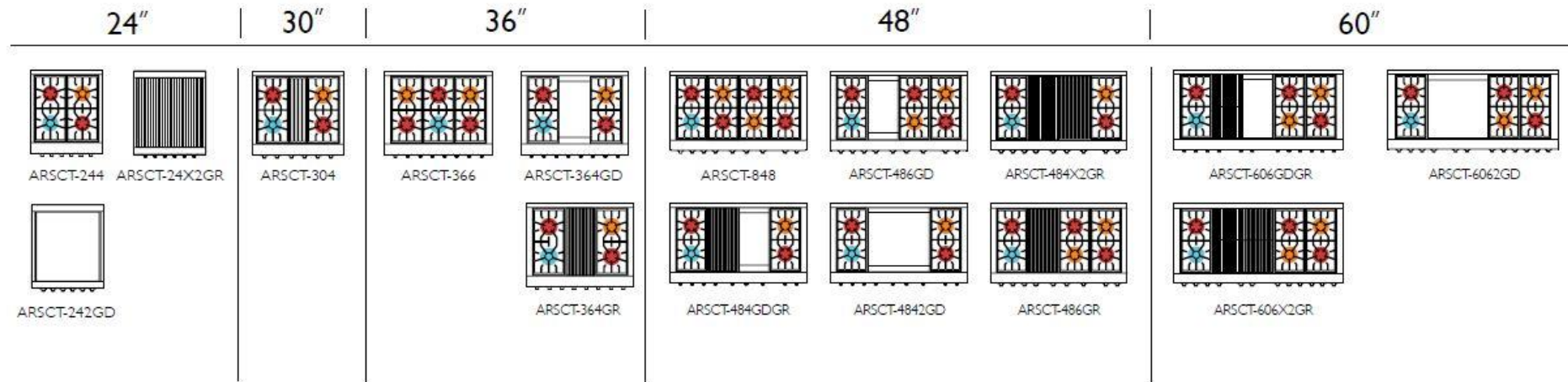

● 17,000 BTU (lg) ● 13,000 BTU (md) ● 9,000 BTU (sm)

MEDALLION BURNER CONFIGURATIONS

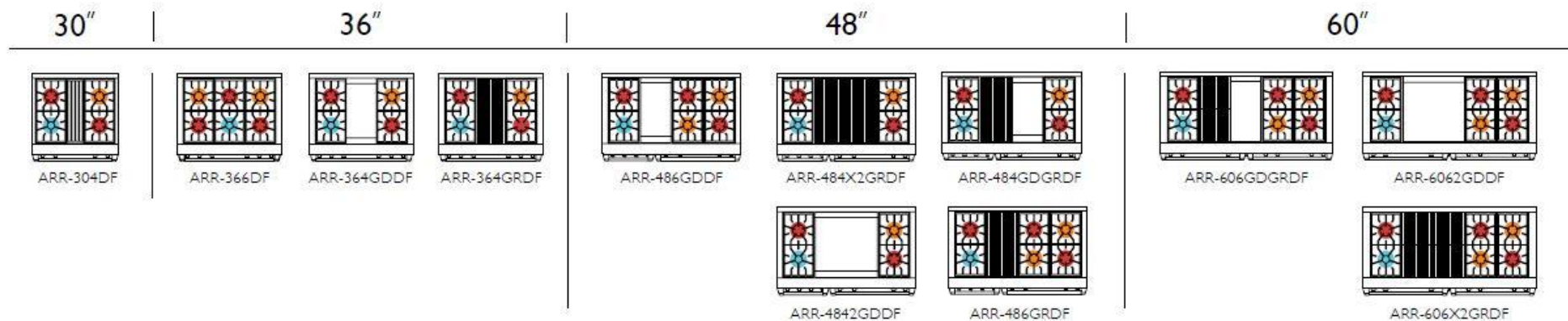

● 17,000 BTU (lg) ● 13,000 BTU (md) ● 9,000 BTU (sm)

PERFORMER SLIDE-IN BURNER CONFIGURATIONS

24"

30"

36"

48"

60"



AROB5CT-244

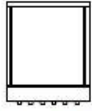

AROB5CT-242GD

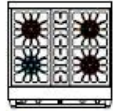

AROB5CT-430

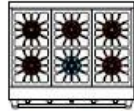

AROB5CT-636

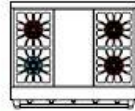

AROB5CT-436GD

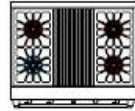

AROB5CT-436GR

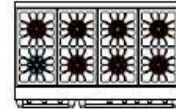

AROB5CT-848

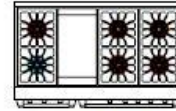

AROB5CT-648GD

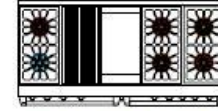

AROB5CT-606GDGR

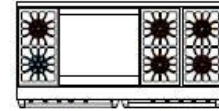

AROB5CT-6602GD



AROB5CT-24X2GD

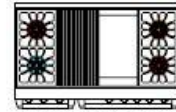

AROB5CT-448GDGR

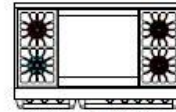

AROB5CT-4482GD

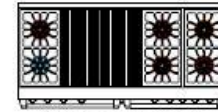

AROB5CT-660X2GR

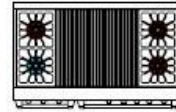

AROB5CT-448X2GR

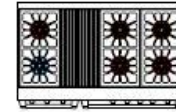

AROB5CT-648GR

● 25,000 BTU (lg) ● 18,000 BTU (md) ● 12,000 BTU (sm)

TROUBLESHOOTING

PROBLEM	POSSIBLE CAUSE	WHAT TO DO
Oven will not heat	No electrical power to the range Gas service is turned off Gas supply has been interrupted Look for red glow of hot surface igniter	Check circuit breakers in house Try to light a surface burner Contact the gas company If no glow, call for service
Oven light does not work	Light switch is in the off position Light is burned out	Try switching the light on Locate and test a new replacement light, unscrew glass lens, remove bad light, replace
Broiler will not light	No electrical power to the range Gas service is turned off Look for red glow of hot surface igniter	Check circuit breakers in house Try to light a surface burner If no glow, call for service
Burner lights, but clicking won't stop	Mis-wired high voltage connections	See that the burners are correctly matched to the high voltage connections
Convection fan does not turn	Switch the fan on Unit in broil mode Bad fan	Use the control panel switch Turn thermostat to bake temperatures Call for service
Igniters keep clicking	Reverse polarity of the electrical supply line Poor electrical ground	Check the polarity with hand held tester Be sure range power cord has three prongs and plugs directly (no adapter) into the power receptacle
Condensation on the oven window	Cold appliance	During cold weather, it is normal for some condensation to appear of the window, it will disappear in about ten minutes.
Foods over-cook	Defective thermostat Incorrect temperature or cooking time	Watch that thermostat indicator light cycles on and off every five or ten minutes at temperature Reduce cooking time or temperature

RESIDENTIAL UNITS

MEDALLION SERIES ARE ALL DUAL FUEL SEALED BURNERS

CUISINE SERIES (SEALED BURNERS)

ALL RANGES & COOKTOPS GO UP TO 60" IN SIZE AND CAN BE CONFIGURED IN DIFFERENT VARIATIONS

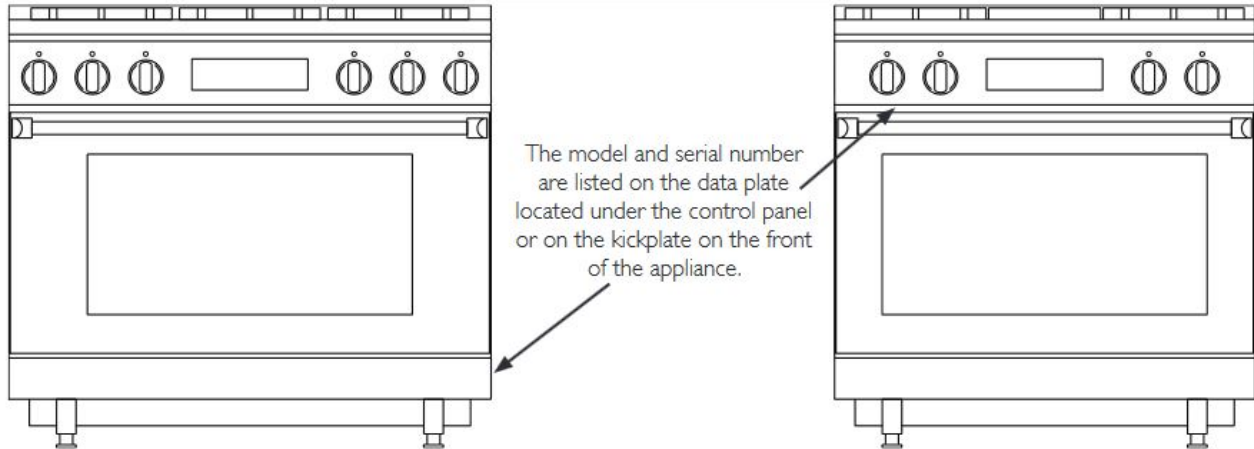

RATING PLATE - The location of the rating plate is shown above. The information on the rating plate defines the model, serial number, gas type (natural or liquid propane), operating pressures and burner BTU ratings. Keep this information for future reference. It is essential for proper identification of the unit when requesting additional information or factory support.

		AMERICAN	
Intertek 3013258		American Range 13692 DESMOND ST., PACOMA, CA 91331 (www.americanrange.com)	
MODEL NO.	ARR-304DF	GAS TYPE	XXX
SERIAL NO.	XXXXXX-XXX	MAN. PRESS.	X.X
		BTU INPUT/HR/SECTION	
COOK TOP Large	17,000	Medium	13,500
		Small	9,000
VOLTS	240	AMPS	30
PHASE	1	CYCLES	60
CONVECTION	2200W	GRIDDLE	
BAKE 30	3500W	BROIL 30	3500W
BAKE 18	3500W	BROIL 18	3500W
GRILL			
ANSI Z21.1b - HOUSEHOLD COOKING APPLIANCES ANSI/UL 858-2005 CSA C22.2 No. 61 Household Cooking Appliances			

Rating Plate